

MACK GRANITE







# DURABLE AND STYLISH

NO WONDER IT'S ONE OF THE MOST POPULAR TRUCKS ON EARTH

The Mack® Granite™ represents a milestone in vocational truck engineering. From its stronger frame specially designed for the harsh work of the jobsite to its powerful and fuel efficient MP™ engine, this truck delivers all the muscle you need. And with a cab that delivers unmatched comfort, the Mack Granite makes life easy behind the wheel to help you boost profits.





# TAME TOUGH JOBSITES

The Mack® Granite™ comes in two configurations — axle forward or axle back — but either way these trucks are amazing feats of engineering equipped with a number of features to help you work productively. And this newest lineup of Mack trucks more than lives up to the company's reputation for building durable trucks you can rely on. In short, today's Mack Granite is still Built Like A Mack Truck® with a pride of craftsmanship unmatched in the trucking industry.



GRANITE TRACTOR



DUMP



MIXER



TANDEM STEER MIXER



ROLLOFF



DUMP WITH LIFT AXLE





REAR LOADER



TRI-DRIVE TRACTOR



SNOWPLOW



FIVE AXLE DUMP



MEDIUM HEAVY DUTY



**AERODYNAMIC DESIGN:** The Mack® Bulldog® sits low on Granite's sloped hood providing improved aerodynamics on the road and excellent visibility on the jobsite. And the larger radiator opening provides better cooling with less fan engagement.

**DURABLE HEADLIGHTS:** The LEXAN® headlight covers are impact resistant to handle the punishment of rocky jobsites and offer easy accessibility for replacing bulbs without a single tool.

**THREE-PIECE BUMPER:** Granite™ has a three-piece stylized front bumper that makes replacement easy and economical.

**SPLASH SHIELDS:** Hood splash shields keep the engine compartment clean extending component life, and they lift with the hood to create more room for technicians to work.

**DURABLE HOOD:** Hood isolators allow the hood to flex independently for increased durability over rough terrain.

**GALVANIZED STEEL CAB:** Granite's durable galvanized steel cab is mounted on airbags and shocks and stabilized with sway bars, so while the truck soaks up the rough stuff, the driver stays comfortable, rested and productive.

**RUBBER-SEALED WINDSHIELD:** Available with a one-piece or two-piece windshield, both are isolated in a rubber seal, which puts less stress on the windshield and makes it easier to replace.

**COLLAPSIBLE MIRRORS:** Collapsible mirrors fold in to eliminate door sheet metal damage in tight jobsite conditions. Heated, lighted and motorized mirrors are available.

**EASY CAB ENTRY:** Sculpted, self-cleaning steps and a full-size grab bar provide an extra measure of safety getting in and out of the cab.





**CAB MOUNTED EXHAUST:** The exhaust is flush with the back of cab to provide 10 inches more room for body builders as compared to a stanchion-mounted exhaust.

**OPTIMIZED CHASSIS COMPONENT MOUNTING:** The air tanks and battery box are mounted under the cab and forward for easy access and body integration. There are also in-frame mounted steel and aluminum air tanks available.

**“D” SHAPED FUEL TANK:** A full selection of aluminum or steel fuel tanks are available up to 116 gallons in a unique tank design that holds more fuel in the same space.

**CAB AIR SPRINGS:** Drivers can work more comfortably thanks to large, outboard-mounted air springs that provide cushioning, stability and reduced vibration.

**HOOD SAFETY LATCH:** The hood safety latch engages automatically and keeps the hood up, even in the windiest conditions. Disengage the latch by simply flipping it up before closing the hood.

**LARGE PEEP WINDOW:** The large peep window and visibility door provide exceptional views, and the quick release mechanism allows easy access for cleaning.

**SUN VISOR:** Stainless steel or painted sun visors are available.

**FRONT FENDERS:** Flexible hood-mounted fender extensions are positioned to protect the hood and control road splash.

**AIR INTAKES:** Granite features optional bright finish air intake vents.



# A WELL-DESIGNED DASH IS WITHIN REACH

Sitting in the driver's seat of the Granite™ is a lot like sitting in a cockpit. The dash wraps around so all switches and controls are close to the driver. There's no stretching, so there's less fatigue. Lighting controls can be reached from the ground to facilitate pre-trip inspections. The standard instrument cluster has been enhanced to include integrated gauge warning lamps, an engine oil temperature gauge, a digital voltmeter and a water-in-fuel indicator. A large, easy-to-read, standard driver display features an odometer, maintenance indicator, hour meter, Sweet Spot indicator and an ambient temperature gauge to name a few.



**DASH FINISHES:** The dash comes nicely appointed in three finishes: brushed nickel (above), charcoal (at right, opposite page) or woodgrain.

**MACK® RADIO:** The Mack line of premium radios features optional hands-free Bluetooth® communication along with satellite radio and an auxiliary input for MP3 players.



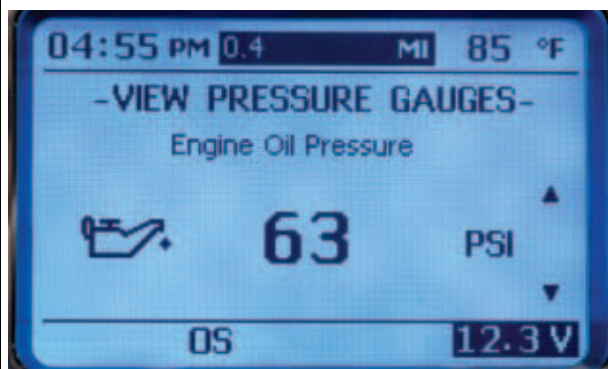

**CO-PILOT™:** Granite features the Co-Pilot driver information display. Mounted high and centered in the dash for easy reading, this large display sets the industry standard. Drivers can easily toggle through a four-button steering-column stalk. This innovative display has 50 screens that provide real-time fuel economy and trip data, detailed maintenance and fault summaries, and supplemental sensor readings. Co-Pilot allows you to equip your truck with specialized features like Theft Deterrence, the Mack Fuel Economy Incentive Program and GuardDog™ Maintenance Monitoring System.

**V-MAC® IV:** Electronics offer both drivers and managers a way to boost productivity. The Mack Granite has our time-tested and road-proven Vehicle Management and Control System or V-MAC IV. This next-generation of advanced electronics gives you greater control of your costs and lets you monitor your truck and engine better than ever. In addition to over a hundred proven programmable features, V-MAC IV adds a host of new items, including ABS-based tamper detection, integrated starter protection and programmable daytime running light overrides. V-MAC IV electronics comes with DataMax™, an advanced trip recorder that captures vehicle trip histories, duty cycle information and scheduled maintenance intervals.

**STEERING COLUMN:** The steering column can be adjusted to an infinite amount of positions for maximum comfort, increased belly room and improved visibility of all gauges by simply pressing the quick-release foot pedal.



# A TRUE SANCTUARY FOR DRIVERS

Granite™ has a spacious cab that defines comfort. Its ergonomic design gives drivers plenty of leg, belly and headroom. Air-suspended cab mountings protect drivers from harsh, rough roads. Getting in and out of the cab is nearly effortless thanks to the strategically placed steps and grab handles. And the interior is easy to clean — from the tough, paw-print signature floor mat to the beautiful dash.

**SUPERIOR CAB LIGHTING:** The Granite cab features best-in-class, four-point cab lighting that reduces dangerous glare and illuminates key spots in the cab.

**LIGHTING CONTROLS:** Lighting controls can be easily accessed to facilitate pre-trip inspections.

**OVERHEAD STORAGE:** The cab has plenty of convenient storage bins as the roomy overhead console is divided into three compartments — with netting to better hold your belongings, and a center compartment ideal for mounting a CB radio.

**STAY ORGANIZED:** There's a place in this cab for all your stuff. Drivers will find a large dispatch box in the rear panel for more storage, as well as a specially designed peg to hang a trash bag. Large cup holders are easy to reach and positioned a safe distance from electronics in case of spills.







**DRIVER SEAT:** The air-suspension driver's seat is wide and comfortable, and easily adjusts to fit any body size.



**COMFORTABLE PEDALS:** The pedals on the Mack® Granite are suspended above the cab floor with the accelerator and brake pedals mounted in-line to reduce operator effort while driving. The clutch pedal is available with air assist, lowering the pedal and greatly reducing driver effort. When combined with our new deep cab and strategically placed seat and steering column, drivers conserve energy and work more productively.

## TRIM LEVELS

From the finish on the dash to the style of the steering wheel and a trio of optional trim levels, we worked hard to create an array of choices that fit your style.

### CHAMPION

SLATE GRAY SANDSTONE

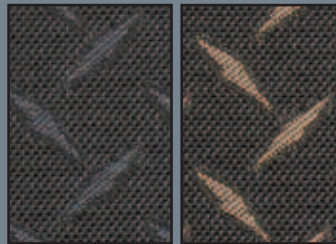

DIAMOND PLATE ACCENT



CHROME WITH A STITCHED LEATHER GRIP

### PEDIGREE

SLATE GRAY SANDSTONE

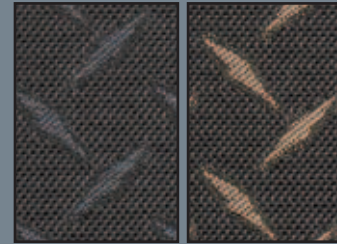

DIAMOND PLATE ACCENT



BRUSHED NICKEL WITH A FIRM GRIP FEEL

### PUREBRED

SLATE GRAY SANDSTONE



DIAMOND PLATE ACCENT



CHARCOAL WITH A FIRM GRIP FEEL



## RAWHIDE™ EDITION

Climb inside the Mack® Granite™ Rawhide Edition and experience cab comforts designed to impress. The well-appointed cab combines a brushed nickel dash, a leather-grip steering wheel and two-tone Ultraleather™ seats with Rawhide Logo and bold stitching to create an envious work environment.

### BUCKSKIN



### DEEP COPPER

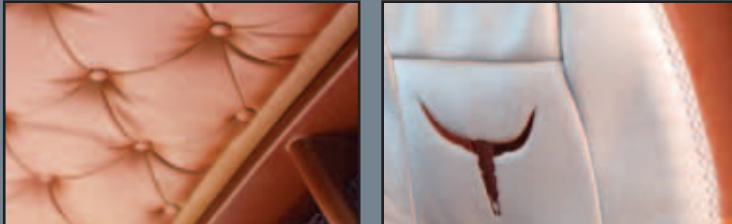

### SLATE GRAY



### OXBLOOD

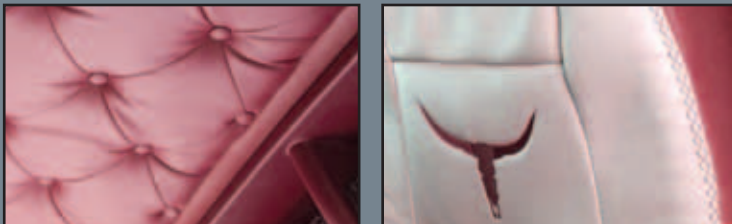

## RAWHIDE INTERIOR

- Ultraleather button-tuck trim in Classic Buckskin, Deep Copper, Slate Gray or Vintage Oxblood
- Leather-grip steering wheel with bright chrome spokes and brushed chrome Mack horn cap
- Premium brushed nickel dash with chrome gauge bezels
- Full gauge cluster
- Co-Pilot™ driver display
- Bostrom® LSO high-back seats in two-tone Ultraleather with Rawhide Logo and bold stitching
- Fixed high-back passenger seat with integral storage compartments
- Power windows and locks with bright-finish cover plate
- Bright-finish door handles
- Floor mat with polished, diamond-plate inserts







## RAWHIDE EXTERIOR

- Bright-finish, dual-vertical stacks with seven-inch chrome Bullhorns
- Stainless steel, 13-inch-deep exterior sun visor
- Quad trumpet air horns with snow shields
- Bright-finish air intake grille
- Bright-finish grille surround
- Chrome bullet LED cab marker and clearance lamps
- Bulldog®-stylized, heated, motorized and illuminated mirrors with integrated convex
- Stainless steel hood latches
- Stainless steel cab skirts
- Polished aluminum fuel tank
- Bright-finish fuel tank steps with three-inch-wide straps
- Polished aluminum air reservoirs
- Polished aluminum battery box cover
- Bright-finish heat shield for Mack Cap DPF
- Extended, stylized bright-finish steel bumper with stone guard
- Bright-finish grab handles



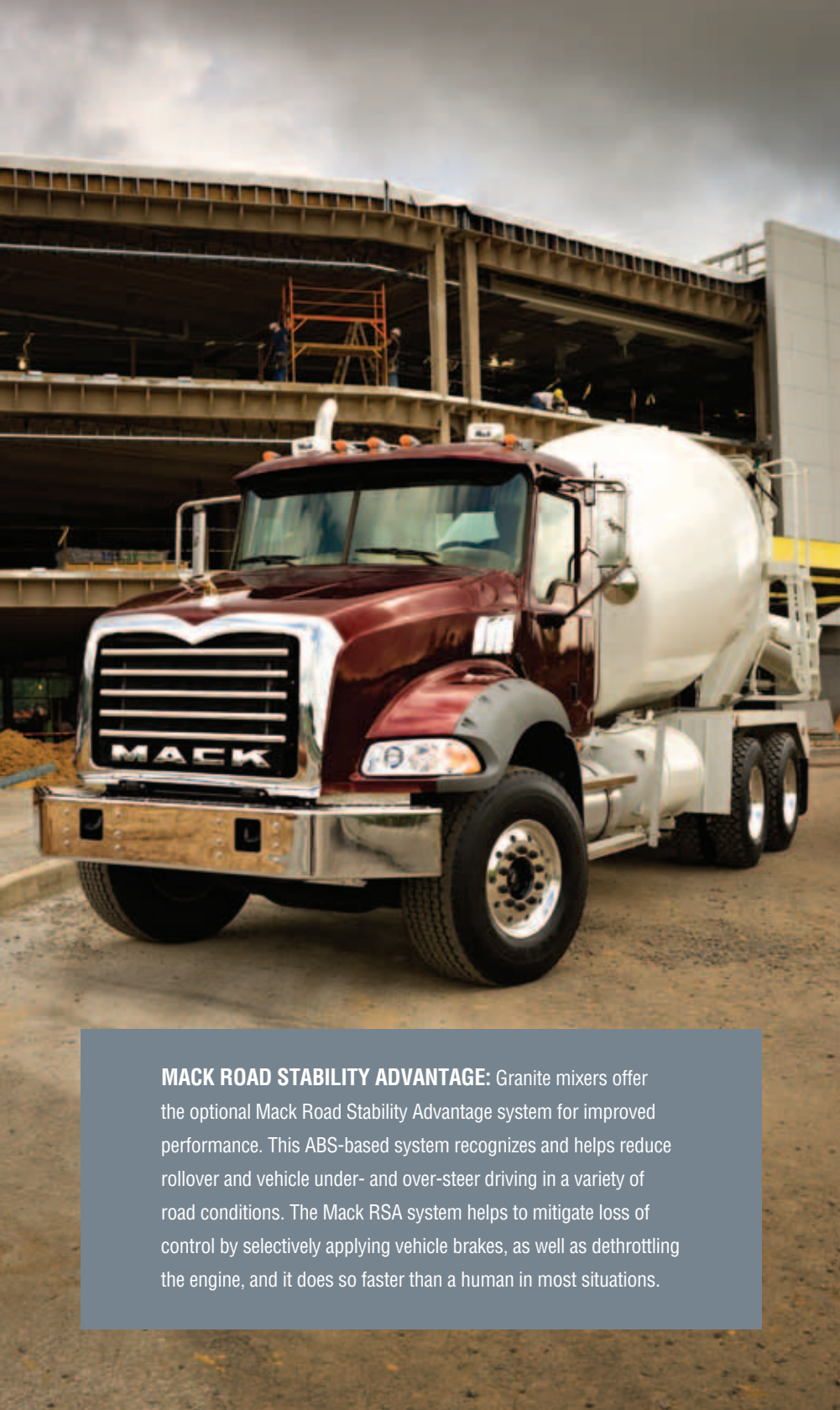

**MACK ROAD STABILITY ADVANTAGE:** Granite mixers offer the optional Mack Road Stability Advantage system for improved performance. This ABS-based system recognizes and helps reduce rollover and vehicle under- and over-steer driving in a variety of road conditions. The Mack RSA system helps to mitigate loss of control by selectively applying vehicle brakes, as well as dethrottling the engine, and it does so faster than a human in most situations.

## A CHASSIS THAT WILL LAST A LIFETIME

Every Mack® Granite™ is built on the proven *Cornerstone*™ chassis that provides rock-solid performance, durability and reliability. *Cornerstone*'s constant frame rail height and high strength steel alloy design creates stronger, lighter frames. It's higher off the ground for maximum ground clearance. The rails and crossmembers were stressed and relentlessly checked for endurance. Trucks using the *Cornerstone* chassis were put through punishing off-road courses as well as placed with customers for on-the-job testing. All to ensure the best chassis Mack has ever built.

**CHASSIS OPTIONS:** With 15 available configurations, each chassis is built with application-specific crossmembers and comes in four frame rail thicknesses (7, 8, 9.5 and 11.1 mm) with optional full or partial 5 mm inside channel reinforcements. For snowplow applications, 20-inch parent frame rail front extensions are available.

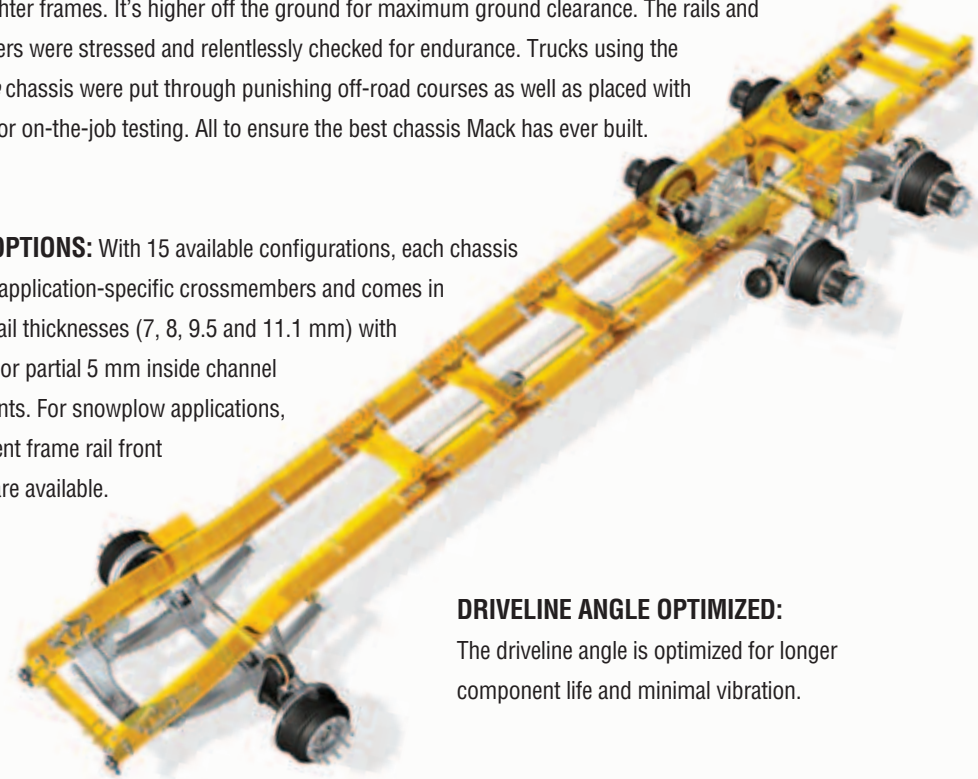

**DRIVELINE ANGLE OPTIMIZED:**  
The driveline angle is optimized for longer component life and minimal vibration.

**UNIMAX™ AXLES:** UniMax steer axle hubs are sealed and maintenance free and require no servicing. The short distance from bumper to tire provides front-end swing clearance, outstanding wheel cuts and an exceptional turning radius.

**TURNS ON A DIME:** The chassis is engineered to provide superior maneuvering in tight spaces. The sloped hood and big mirrors give drivers excellent visibility. The reinforced cab is extremely durable, built to survive thousands of hours of punishment without losing its integrity. Drivers can work more comfortably thanks to large, outboard-mounted air springs that provide cushioning, stability and reduced vibration. Optimal headlight placement and perimeter lighting give drivers the confidence to work in the most treacherous jobsites day or night.



**CENTRAL TIRE INFLATION SYSTEM:** Soft sand or mud is always difficult terrain for a truck. Now, you can have the convenient, one-touch Central Tire Inflation system factory-installed by Mack. This system gives drivers quick and effortless control of tire pressure on the fly because you get better traction on soft ground as the tire footprint expands and ruts are shallow. Take your truck to places previously inaccessible and work more productively.

**BODYLINK III™:** The Granite features BodyLink III wire harness connectors, conveniently located for quick and reliable body hookup. A dash-mounted lamp signal instantly indicates a dump body or load hopper that is not properly lowered. Granite offers maximum body compatibility while eliminating the high cost of relocating components.

**AXLE CAPACITY OPTIONS:** Camelback™, Walking Beam™ or air suspensions are all offered with Granite to fit your specific applications. Front axles and suspensions are available from 12,000- to 23,000-lb. capacity. Rear axles and suspensions are offered from 38,000- to 65,000-lb. capacity.



CAMELBACK



WALKING BEAM



## GRANITE MEDIUM HEAVY DUTY

The Mack Granite Medium Heavy Duty is built to fit your business. It delivers the durability you expect from a Mack truck, yet it is optimized to fit the way you work today. This Granite MHD model is lighter and is equipped with a 9-liter Cummins® engine and is available with Eaton® manual or Allison® automatic transmissions. It is ideally configured for shorter runs and lighter-duty cycles, but it still rides on the proven *Cornerstone* chassis, giving you the strength to tackle a host of rugged applications.

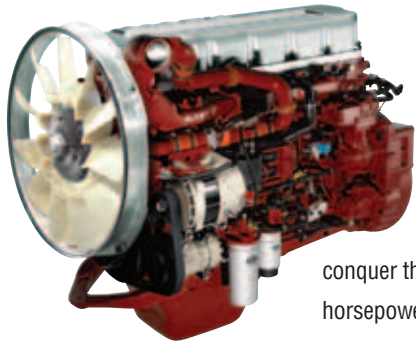

## THESE ENGINES ARE ALL MUSCLE

The MP™ Engine Series is the heartbeat of the Mack® Granite™. These highly fuel-efficient engines deliver plenty of horsepower plus great low-end torque to give you all the muscle you need to conquer the road. The MP7 engine has a horsepower range from 325 to 405 HP while the MP8 provides horsepower from 415 to 505 HP.

**EASY SERVICING:** The MP Engine Series features 300-hour or 16,000-mile oil drain intervals (whichever comes first) and provides convenient access points that make servicing a snap.

**SINGLE OVERHEAD CAM:** These state-of-the-art engines have a single overhead cam with ultra-high-pressure fuel injection.

**VARIABLE GEOMETRY TURBOCHARGER:** The electronically controlled Variable Geometry Turbocharger incorporates the latest technology to cool both the turbo and the actuator.

**BUILT LIKE A MACK TRUCK®:** The MP Engine Series is designed with fewer parts, including one-piece steel pistons and stronger bearings and cylinder heads, giving operators a true powerplant that's built to last.

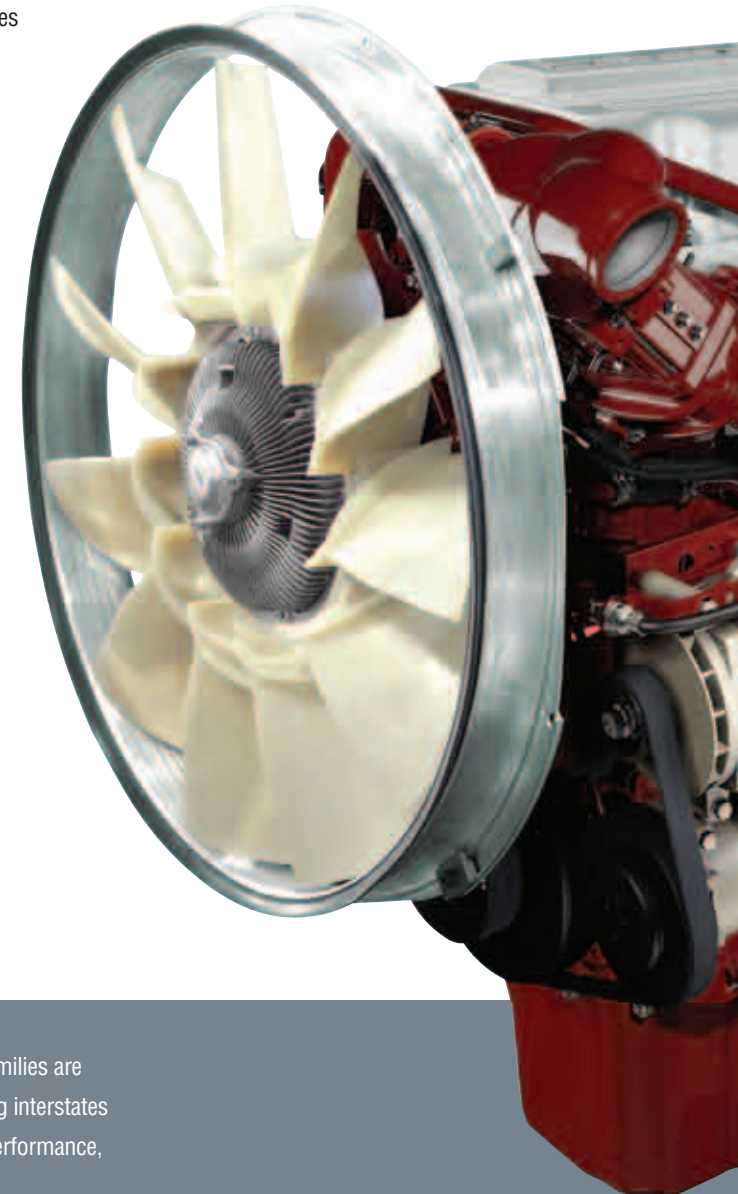

MAXIDYNE®	
ENGINE	HP
MP7	325M
MP7	365M
MP7	405M
MP8	425M
MP8	455M
MP8	505M
ENGINE TORQUE LEVELS	
MP7: 1,200–1,480 lb.-ft.	
MP8: 1,570–1,760 lb.-ft.	

MAXICRUISE®	
ENGINE	HP
MP7	345C
MP7	365C
MP7	395C
MP8	415C
MP8	445C
MP8	505C
ENGINE TORQUE LEVELS	
MP7: 1,360–1,560 lb.-ft.	
MP8: 1,660–1,760 lb.-ft.	

**ENGINEERED TO FIT HOW YOU WORK:** The MaxiCruise and Maxidyne engine families are best suited for vocational applications. The MaxiCruise engine performs best on rolling interstates and in on- and off-road applications. The Maxidyne engine provides power for high-performance, severe-duty conditions, especially in off-road applications.



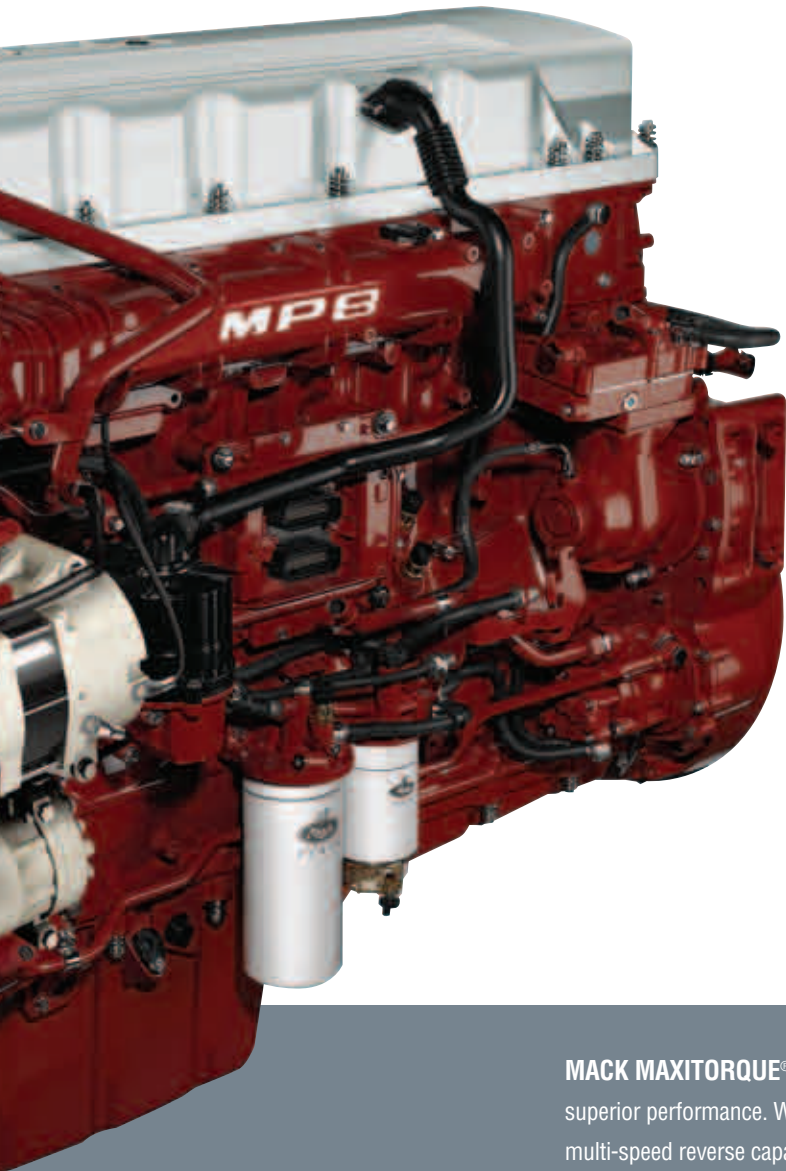

**MACK CLARTECH™ SCR SYSTEM:** Mack remains at the forefront of engine development, incorporating selective catalytic reduction (SCR) technology into our entire MP engine platform. The Mack ClearTech SCR System creates clean-running engines that boast near-zero emissions (without the use of emissions credits) and even better fuel efficiency. Already used successfully in hundreds of thousands of trucks around the world, SCR is a proven, reliable approach.

**ClearTech™**  
**SCR SYSTEM**

**MACK POWERLEASH™:** The Mack PowerLeash engine brake provides more braking horsepower through mid-RPM ranges, and weighs 50 pounds less than other engine brakes. It is fully integrated with the MP Engine Series, and with better braking over the entire speed range, PowerLeash delivers the most retarding horsepower ever in a Mack engine brake. Drivers will immediately notice the near-instantaneous engine braking, giving drivers confidence behind the wheel. For trucks with automated transmissions, the quick response also enhances downshifting performance.

**INTEGRATED POWERTRAINS:** Mack is the only truck manufacturer offering the benefits of integration and single-source accountability for the engine, transmission and chassis, giving you not only the industry's best-built transmission, but also peace of mind knowing all Mack transmissions are engineered to work in concert with the engine to create powerful, reliable powertrains.

**MACK MAXITORQUE® ES TRANSMISSION:** Every Mack transmission is designed to deliver superior performance. With the industry's only triple-countershaft design; revolutionary shifttable, multi-speed reverse capabilities; standard, one-piece aluminum casings; and more PTO mounting options than any other transmission; the Mack Maxitorque ES transmissions are a breed apart.

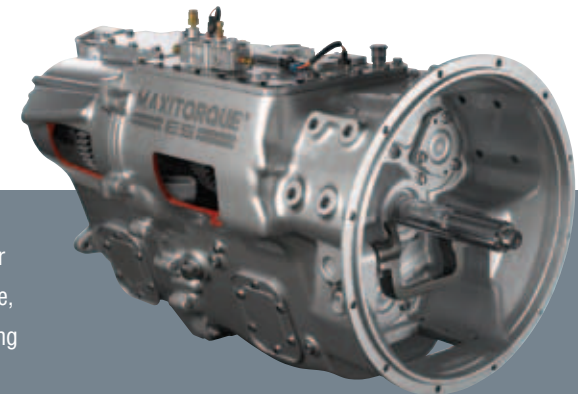

<b>ENGINE</b>	
Horsepower and Torque	
MP8 – 13 Liter With 415 To 505 HP And Torque Ratings From 1,570 To 1,760 lb.-ft.	
MP7 – 11 Liter With 325 To 405 HP And Torque Ratings From 1,200 To 1,560 lb.-ft.	
Cummins® ISL9 – 9 Liter With 330 HP or 345 HP With A Maximum 1,150 lb.-ft. of Torque	
Mack PowerLeash™ Engine Brake – (MP7 – 420 HP At 2,100 RPM / MP8 – 425 HP At 2,100 RPM)	
REPTO (Rear Engine Power Takeoff) – SAE 1350	
V-MAC® IV – Total Vehicle Electronics	
Air Compressor – 18.5 cfm / 37.4 cfm	
Mack Coolant Conditioner	
ClearTech™ SCR – Available Horizontal or Back-Of-Cab	
Diesel Particulate Filter – Mack Cap (Passenger Side Under Step)	
Single Or Dual Vertical Exhaust	
Silicone Engine Hoses And Tubing	
Poly-V Fan Belt With Automatic Tensioner	
Fan Drive, Electronically Modulated Multi-Speed Viscous / On-Off	
Flywheel Housing – Aluminum (Lightweight)	
Radiator – Aluminum Core	
Electronic Starter Interlock	

<b>TRANSMISSIONS</b>			
Clutch – Self And Manual Adjusting Mechanical Cable – Standard			
Air Operated Clutch Assist Pedal – Optional			
Transmission Bell Housing – Aluminum Or Iron			
PTO (Power Takeoff) Up To Six Openings, SAE 6 + 8			
Transmissions*			
Mack TM308 Maxitorque® ES Shift Triple-Counter Shaft	8 Speed	17.77 / 0.71 Ratio (Low/High)	
Mack TM308M Maxitorque ES Shift Triple-Counter Shaft	8 Speed	17.77 / 0.71 Ratio (Low/High)	
Mack TM309 Maxitorque ES Shift Triple-Counter Shaft	9 Speed	25.21 / 0.71 Ratio (Low/High)	
Mack TM309M Maxitorque ES Shift Triple-Counter Shaft	9 Speed	25.21 / 0.71 Ratio (Low/High)	
Mack T309 Maxitorque ES Shift Triple-Counter Shaft	9 Speed	11.40 / 0.71 Ratio (Low/High)	
Mack T309 (LR) Maxitorque ES Shift Triple-Counter Shaft	9 Speed	13.93 / 0.71 Ratio (Low/High)	
Mack T310 Maxitorque ES Shift Triple-Counter Shaft	10 Speed	13.81 / 0.73 Ratio (Low/High)	
Mack T310M Maxitorque ES Shift Triple-Counter Shaft	10 Speed	17.35 / 0.73 Ratio (Low/High)	
Mack T310ME Maxitorque ES Shift Triple-Counter Shaft	10 Speed	17.35 / 0.73 Ratio (Low/High)	
Mack T310MLR Maxitorque ES Shift Triple-Counter Shaft	10 Speed	27.31 / 0.71 Ratio (Low/High)	
Mack T313 Maxitorque ES Shift Triple-Counter Shaft	13 Speed	13.44 / 0.74 Ratio (Low/High)	
Mack T313LR Maxitorque ES Shift Triple-Counter Shaft	13 Speed	16.42 / 0.71 Ratio (Low/High)	
Mack T318 Maxitorque ES Shift Triple-Counter Shaft	18 Speed	13.44 / 0.71 Ratio (Low/High)	
Mack T318LR Maxitorque ES Shift Triple-Counter Shaft	18 Speed	16.42 / 0.71 Ratio (Low/High)	
Allison® – EVS Or RDS	5 Speed/6 Speed	3.51 / 0.74 Ratio (Low/High)	
Eaton® Fuller® RoadRanger® Twin Counter Shaft	9 Speed	12.57 / 0.73 Ratio (Low/High)	
Eaton Fuller RoadRanger Twin Counter Shaft	10 Speed	12.69 / 0.74 Ratio (Low/High)	
Eaton Fuller RoadRanger Twin Counter Shaft	11 Speed	26.08 / 0.73 Ratio (Low/High)	
Eaton Fuller RoadRanger Twin Counter Shaft	13 Speed	12.31 / 0.73 Ratio (Low/High)	
Eaton Fuller RoadRanger Twin Counter Shaft	15 Speed	13.31 / 0.79 Ratio (Low/High)	
Eaton Fuller RoadRanger Twin Counter Shaft	18 Speed	14.40 / 0.73 Ratio (Low/High)	

\*Other Supplier Transmissions Available

<b>ELECTRICAL</b>	
12-Volt Electrical System	
Battery Box – Steel With Molded Plastic Cover Mounted LH Rail	
Courtesy Light Switch – Headlamp And Clearance	
Daytime Running Lights	
Electric Circuit Protection Package	
Waterproof Electrical Connections	
Headlights – Halogen Flush With Replaceable Bulbs	
Step-Mounted LED Work Lights	

<b>AIR/BRAKE</b>	
Dual Air Brake System	
Anti-Lock Brake System With Or Without Traction Control	
Mack Road Stability Advantage System	

<b>CAB INTERIOR/EXTERIOR SPECIFICATIONS</b>	
Air Conditioner With Integral Heater And Replaceable Filter	
Air Cleaner With Restriction Monitor	
Cab Mounting – Four-Point System With Two Air Bags And Canted Shocks	
Interior Lighting, 2 Lamps LH / 2 Lamps RH	
Galvanized Steel Visibility Doors With Passenger Peep Window	
Keyless Entry	
Floor Mats – Polyurethane Mack Signature Pawprint	
Grille – Silver Painted Or Bright Finish With Or Without Grille Surround	
Hood And Fenders – Fiberglass, Camoplast	
Fuel Tanks – “D” Shaped 22” and 26”	
Identification And Clearance Lights (5)	
Co-Pilot™ Driver Display	
Instrument Panel – Brushed Nickel, Woodgrain Or Charcoal	
Exterior Mirrors – Bulldog® Stylized Or Aerodynamic Mirrors Available Lighted / Heated / Motorized	
Parking Brake On Indicator Light	
Overhead Console, 3 Storage Compartments With Net Retainers	
12-Volt Auxiliary Power Outlets (2) – Dash Mounted	
AM/FM Stereo CD With Weather Band – Premium Radio Package Available	
Driver Seat – Bostrom Talladega® 915 Mid-Back Air Suspension	
Rider Seat – Mack Fixed Mid-Back Non-Suspension	
Steering Column – Adjustable Tilt And Telescopic	
Rear Storage Pouch	
Interior Sun Visor – Full Width	
Exterior Sun Visor – Bright Finish Or Painted	
Windshield – Safety Tinted 2-Piece	
Safety Tinted Side And Rear Windows	
Intermittent Windshield Wipers	
Paint – Custom Color Available For Cab, Chassis And Wheels	



GRANITE™ AXLE FORWARD DUMP



## FRONT AXLE AND SUSPENSION

Mack UniMax Axles With Integrated Hub
12,000, 14,600, 16,000 (MHD), 18,000, 20,000 And 23,000 lb. Capacity
Hub Material – Ferrous Or Aluminum
Inbound Cast Or Outbound Cast Centrifuse
Brakes – Meritor® “S” Cam Q-Plus With Or Without Dust Shields (16.5 x 7)
Slack Adjusters – Automatic
Suspension – Mack Taperleaf 12,000 – 23,000 lb.
Suspension – Mack Multileaf 12,000 – 23,000 lb.
Steering Gear
Power – 12,000, 12,600 Or 18,000 lb.
Heavy-Duty – 20,000 Or 23,000 lb.

## REAR AXLE AND SUSPENSION

Rear Axle
Bogies – 38,000 – 65,000 lb. Capacity
Tri-Drive – 69,000 lb. Capacity
Special Order – 80,000 – 110,000 lb. Capacity
Carrier
Top-Mounted Aluminum, Double Reduction
Power Divider Lockout
Face-Mounted, Single Reduction (MHD)
Hub Material – Ferrous Or Aluminum
Brakes – Meritor “S” Cam Q-Plus With Or Without Dust Shields (16.5 x 7)
Inbound Cast Or Outbound Cast Centrifuse
Slack Adjusters – Automatic
Suspension
Mack Multileaf (Camelback™), Hendrickson®, Chalmers® RAYDAN®

The information in this brochure was accurate as known as of the date of the publication. Illustrations may not be representative of current product. Mack Trucks, Inc. reserves the right to make changes in specifications, equipment or design, or to discontinue models or options without notice at any time.



GRANITE AXLE BACK MIXER

## CHASSIS DIMENSIONS

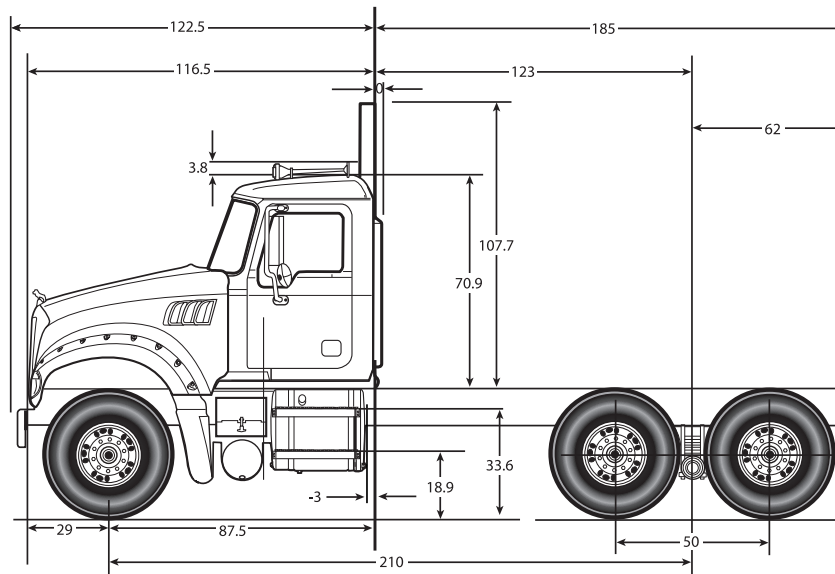

WHEELBASE RANGE: 175 TO 326

AXLE FORWARD SHOWN

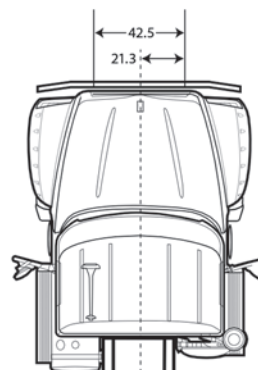

TRI-DRIVE SHOWN

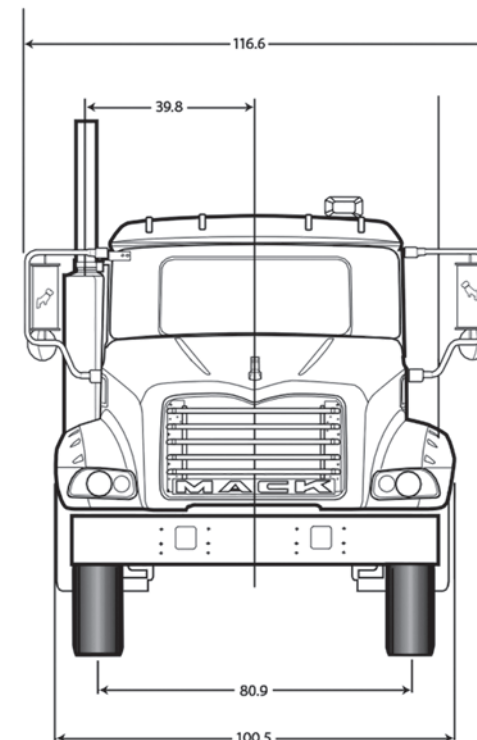
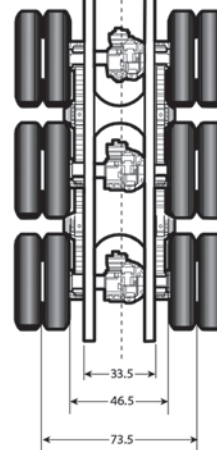

ALL MEASUREMENTS IN INCHES.



BUILT LIKE A MACK TRUCK®

FOR MORE INFORMATION, CALL 1-800-922-MACK (6225) OR VISIT [MACKGRANITE.COM](http://MACKGRANITE.COM) AND [MACKTRUCKS.COM](http://MACKTRUCKS.COM)

©2011 Mack Trucks, Inc. All rights reserved. Mack, Mack and the Bulldog design, Built Like A Mack Truck, Bulldog and all other marks contained herein are registered trademarks of Mack Trucks, Inc. and/or Mack Trucks, Inc. affiliated companies. All other marks contained herein are the property of their respective owners.

The information in this brochure was accurate at the date of publication. Mack Trucks, Inc. reserves the right to make changes in specifications, equipment or design, or to discontinue certain models or options without notice at any time. Warranty terms and services may vary in certain countries. Some of the equipment shown or described in this brochure is available at extra cost through retail organizations and establishments not associated with Mack Trucks, Inc.

1B-G-03/11-SWBR/15M